



Section 8

Stainless Steel Buttweld Fittings & Flanges

Edition 3

Specifications

Stainless Steel Butt Weld Fittings are made from the finest quality stainless steel designed to be dimensionally precise. The advantages of these fittings are its high tensile strength, robust nature and rust free properties.

AAP supplies Stainless Steel butt-weld fittings made from welded stainless steel pipe which is manufactured from 2B or HRAP stainless steel strip, which is formed to shape and longitudinally welded to complete the pipe.

Stainless steel butt-weld fittings are most commonly used in refinery complexes, chemical production and petrochemical engineering.

MATERIAL SPECIFICATIONS - ASTM A182 F316L - ASTM A182 F316

Chemical Composition of ASTM A182 F316L Stainless Steel Buttweld								
C MAX (%)	Si MAX (%)	Mn MAX (%)	P MAX (%)	S MAX (%)	Cr (%)	Mo (%)	Ni (%)	N MAX (%)
0.03	1	2.00	0.05	0.03	16.00-18.00	2.00-3.00	10.00-15.00	0.1

Mechanical Properties of ASTM A182 F316L Stainless Steel Buttweld at Room Temperature		
Tensile Strength N/mm ₂	Yield Point Rp0.2 N/mm ₂ ≥	A5 % ≥
≥ 485	170.00	30.00

*Note: For Sections over 2 in (50mm) in thickness, the minimum tensile strength shall be 106ksi and the minimum yield strength shall be 75ksi

Wall Thickness ASTM A312M				
PIPE SIZE	Schedule 10S		Schedule 40S	
	304/304L & 316/316L		304/304L & 316/316L	
NPS	OUTSIDE DIAMETER	WALL THICKNESS (mm)	OUTSIDE DIAMETER	WALL THICKNESS (mm)
1/8	10.29	1.24	10.29	1.73
1/4	13.72	1.65	13.72	2.24
3/8	17.15	1.65	17.15	2.31
1/2	21.34	2.11	21.34	2.77
3/4	26.67	2.11	26.67	2.87
1	33.41	2.77	33.41	3.38
1 1/4	42.16	2.77	42.16	3.56
1 1/2	48.26	2.77	48.26	3.68
2	60.3	2.77	60.3	3.91
2 1/2	73.03	3.05	73.03	5.16
3	88.9	3.05	88.9	5.49
4	114.3	3.05	114.3	6.02
6	168.28	3.40	168.28	7.11
8	219.18	3.76	219.18	8.18

Standard Tolerances ANSI B-16.9							
ALL FITTINGS				90-DEG AND 45-DEG ELBOWS AND TEES	REDUCERS		
NOMINAL PIPE SIZE INCH	OUTSIDE DIAMETER AT END	INSIDE DIAMETER AT END	WALL THICKNESS	CENTRE TO END	OVERALL LENGTH		
1/2 TO 2 1/2	+ 1/16	± 1/32	NOT LESS THAN 87.5% OF NOMINAL THICKNESS	± 1/16	± 1/16		
	- 1/32						
3 TO 4	± 1/16	± 1/8				± 3/32	± 3/32
5 TO 8	+ 3/32						
10 TO 18	+ 5/32	± 1/8		± 3/32	± 3/32		
	- 1/8						
20 TO 24	+ 1/4	± 3/16	± 3/32	± 3/32			
	- 3/16						

Stainless Steel Buttweld SCH10s 90 Degree Elbow (304/304L)

Stainless Steel Buttweld SCH10S L/R 90 Degree Elbow 304/304L					
AAP CODE	IMPERIAL SIZE	A	B	C	APPROX KG/PC
SWE1030425	1	33.4	27.9	38	0.1
SWE1030432	1 1/4	42.2	36.7	48	0.2
SWE1030440	1 1/2	48.3	42.8	57	0.3
SWE1030450	2	60.3	54.8	76	0.5
SWE1030465	2 1/2	73.0	66.9	95	0.9
SWE1030480	3	88.9	82.8	114	1.3
SWE1030494	4	114.3	108.2	152	2.1
SWE1030496	6	168.3	161.5	229	5.5
SWE1030498	8	219.1	211.6	305	10.2

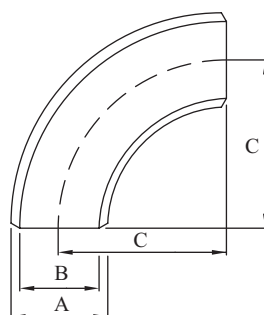

Stainless Steel Buttweld SCH10s Equal Tee (304/304L)

Stainless Steel Buttweld SCH10S Equal Tee 304/304L					
AAP CODE	IMPERIAL SIZE	A	B	C	APPROX KG/PC
SWT1030425	1	33.4	27.9	38	0.3
SWT1030432	1 1/4	42.2	36.7	48	0.5
SWT1030440	1 1/2	48.3	42.8	57	0.7
SWT1030450	2	60.3	54.8	64	0.9
SWT1030465	2 1/2	73.0	66.9	76	1.4
SWT1030480	3	88.9	82.8	86	1.8
SWT1030494	4	114.3	108.2	105	3.5
SWT1030496	6	168.3	161.5	124	5.4
SWT1030498	8	219.1	211.6	143	8.0

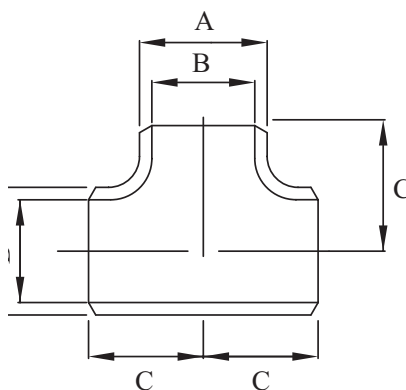

Stainless Steel Buttweld SCH10s 90 Degree Elbow (316/316L)

Stainless Steel Buttweld SCH10S 90 Degree Elbow 316/316L					
AAP CODE	IMPERIAL SIZE	A	B	C	APPROX KG/PC
SWE1031615	1/2	21.34	17.12	38	0.1
SWE1031620	3/4	26.67	22.45	28	0.1
SWE1031625	1	33.4	27.9	38	0.1
SWE1031632	1 1/4	42.2	36.7	48	0.2
SWE1031640	1 1/2	48.3	42.8	57	0.3
SWE1031650	2	60.3	54.8	76	0.5
SWE1031665	2 1/2	73.0	66.9	95	0.9
SWE1031680	3	88.9	82.8	114	1.3
SWE1031694	4	114.3	108.2	152	2.1
SWE1031696	6	168.3	161.5	229	5.5

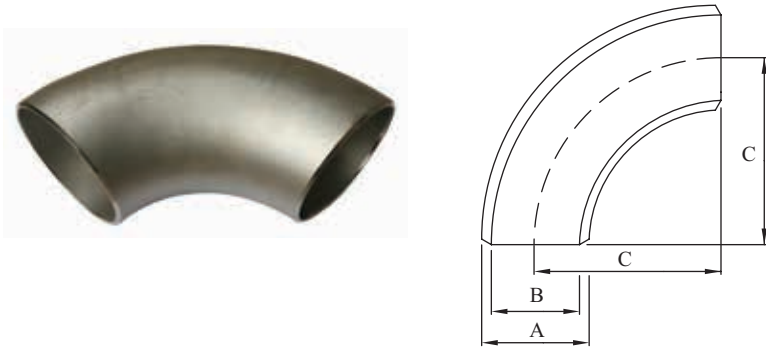

Stainless Steel Buttweld SCH10s 45 Degree Elbow (316/316L)

Stainless Steel Buttweld SCH10S L/R 45 Degree Elbow 316/316L					
AAP CODE	IMPERIAL SIZE	A	B	C	APPROX KG/PC
SWEF1031625	1	33.4	27.9	22	0.1
SWEF1031632	1 1/4	42.2	36.7	25	0.2
SWEF1031640	1 1/2	48.3	42.8	29	0.2
SWEF1031650	2	60.3	54.8	35	0.3
SWEF1031665	2 1/2	73.0	66.9	44	0.6
SWEF1031680	3	88.9	82.8	51	0.8
SWEF1031694	4	114.3	108.2	64	1.4
SWEF1031696	6	168.3	161.5	95	3.6

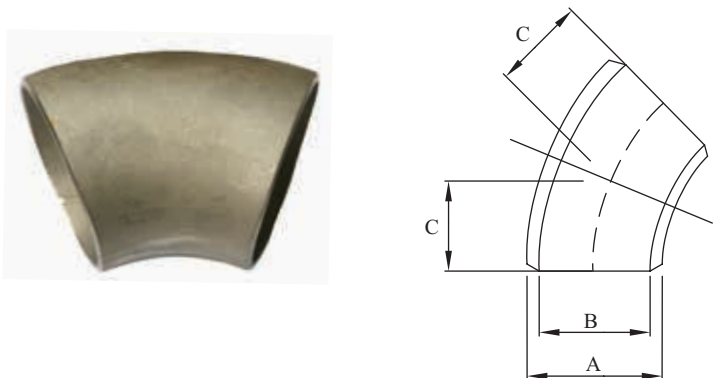

Stainless Steel Buttweld SCH10s Equal Tee (316/316L)

Stainless Steel Buttweld SCH10S Equal Tee 316/316L					
AAP CODE	IMPERIAL SIZE	A	B	C	APPROX KG/PC
SWT1031615	1/2	0.0	17.1	38	0.2
SWT1031620	3/4	26.7	22.5	28	0.2
SWT1031625	1	33.4	27.9	38	0.3
SWT1031632	1 1/4	42.2	36.7	48	0.5
SWT1031640	1 1/2	48.3	42.8	57	0.7
SWT1031650	2	60.3	54.8	64	0.9
SWT1031665	2 1/2	73.0	66.9	76	1.4
SWT1031680	3	88.9	82.8	86	1.8
SWT1031694	4	114.3	108.2	105	3.5
SWT10316196	6	168.3	161.5	124	5.4

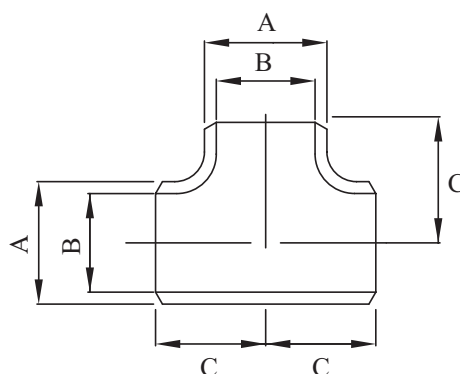

Stainless Steel Buttweld SCH10s Cap (316/316L)

Stainless Steel Buttweld SCH10S Cap 316/316L					
AAP CODE	IMPERIAL SIZE	A	B	C	APPROX KG/PC
SWC1031625	1	27.9	33.4	38	0.1
SWC1031632	1 1/4	36.7	42.2	38	0.1
SWC1031640	1 1/2	42.8	48.3	38	0.1
SWC1031650	2	54.8	60.3	38	0.1
SWC1031665	2 1/2	66.9	73.0	38	0.2
SWC1031680	3	82.8	88.9	51	0.3
SWC1031694	4	108.2	114.3	64	0.7
SWC1031696	6	161.5	168.3	89	1.4

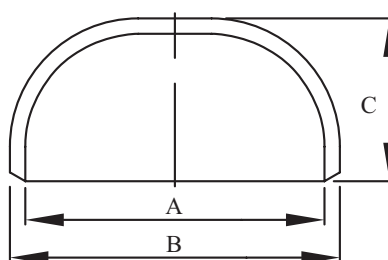

Stainless Steel Buttweld SCH10s Concentric Reducer (316/316L)

Stainless Steel Buttweld SCH10S Concentric Reducer 316/316L							
AAP CODE	IMPERIAL SIZE	A1	A2	B1	B2	C	APPROX KG/PC
SWCR103162515	1 x 1/2	33.4	27.9	21.34	17.12	51	0.1
SWCR103162520	1 x 3/4	33.4	27.9	26.67	22.45	51	0.1
SWCR103164025	1 1/2 x 1	48.3	42.8	33.4	27.9	64	0.2
SWCR103165025	2 x 1	60.3	54.8	33.4	27.9	76	0.3
SWCR103165040	2 x 1 1/2	60.3	54.8	48.3	42.8	76	0.3
SWCR103166550	2 1/2 x 2	73.0	66.9	60.3	54.8	89	0.5
SWCR103168050	3 x 2	88.9	82.8	60.3	54.8	89	0.6
SWCR103169480	4 x 3	114.3	108.2	88.9	82.8	102	0.9
SWCR103169694	6 x 4	168.3	161.5	114.3	108.2	140	2.0
SWCR103169896	8 x 6	219.18	211.66	161.5	168.3	152	3.54

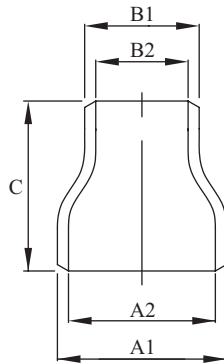

Stainless Steel Buttweld SCH40s 90 Degree Elbow (304/304L)

Stainless Steel Buttweld SCH40S 304/304L L/R 90 Degree Elbow Elbow					
AAP CODE	IMPERIAL SIZE	A	B	C	APPROX KG/PC
SWE4030425	1	33.4	26.6	38	0.2
SWE4030432	1 1/4	42.2	35.1	48	0.3
SWE4030440	1 1/2	48.3	40.9	57	0.4
SWE4030450	2	60.3	52.5	76	0.7
SWE4030465	2 1/2	73.0	62.7	95	1.4
SWE4030480	3	88.9	77.9	114	2.2
SWE40304100	4	114.3	102.3	152	4.5
SWE40304150	6	168.3	154.1	229	10.9

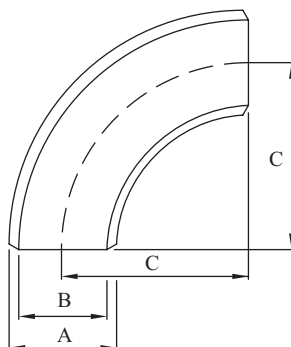

Stainless Steel Buttweld SCH40s Equal Tee (304/304L)

Stainless Steel Buttweld SCH40S 304/304L Equal Tee					
AAP CODE	IMPERIAL SIZE	A	B	C	APPROX KG/PC
SWT4030425	1	33.4	26.6	38	0.3
SWT4030432	1 1/4	42.2	35.1	48	0.6
SWT4030440	1 1/2	48.3	40.9	57	0.9
SWT4030450	2	60.3	52.5	64	1.3
SWT4030465	2 1/2	73.0	62.7	76	2.2
SWT4030480	3	88.9	77.9	86	3.3
SWT4030494	4	114.3	102.3	105	5.3
SWT4030496	6	168.3	154.1	124	11.0

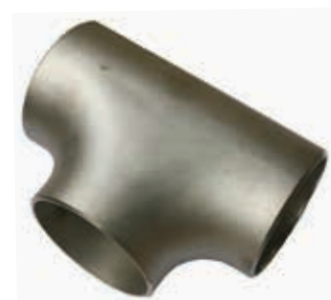
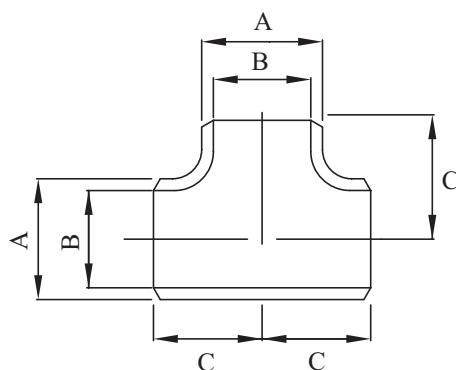

Stainless Steel Buttweld SCH40s 90 Degree Elbow (316/316L)

Stainless Steel Buttweld SCH40S 316/316L L/R Elbow					
AAP CODE	IMPERIAL SIZE	A	B	C	APPROX KG/PC
SWE4031625	1	33.4	26.6	38	0.2
SWE4031632	1 1/4	42.2	35.1	48	0.3
SWE4031640	1 1/2	48.3	40.9	57	0.4
SWE4031650	2	60.3	52.5	76	0.7
SWE4031665	2 1/2	73.0	62.7	95	1.4
SWE4031680	3	88.9	77.9	114	2.2
SWE4031694	4	114.3	102.3	152	4.5

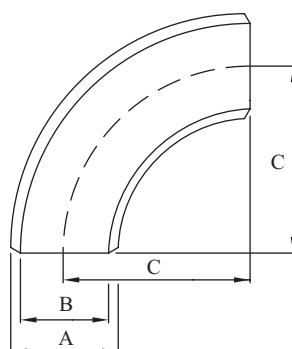

Stainless Steel Buttweld SCH40s Equal Tee (316/316L)

Stainless Steel Buttweld SCH40S 316/316L Equal Tee					
AAP CODE	IMPERIAL SIZE	A	B	C	APPROX KG/PC
SWT4031625	1	33.4	26.6	38	0.3
SWT4031632	1 1/4	42.2	35.1	48	0.6
SWT4031640	1 1/2	48.3	40.9	57	0.9
SWT4031650	2	60.3	52.5	76	1.3
SWT4031665	2 1/2	73.0	62.7	76	2.2
SWT4031680	3	88.9	77.9	114	3.3
SWT4031694	4	114.3	102.3	152	5.3

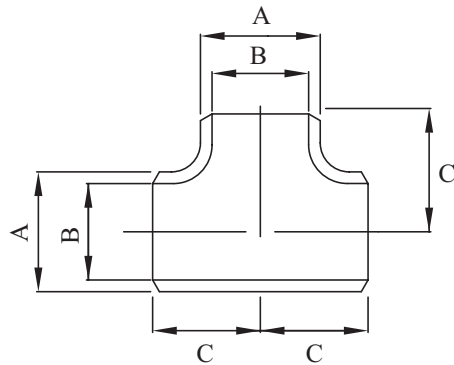
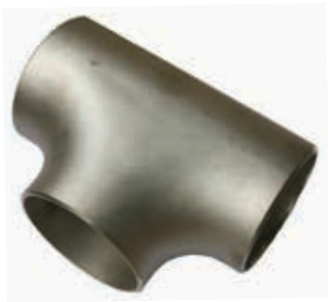

Stainless Steel Buttweld SCH40s Concentric Reducer (316/316L)

Stainless Steel Buttweld SCH40S 316/316L Con Reducer							
AAP CODE	IMPERIAL SIZE	A1	A2	B1	B2	C	APPROX KG/PC
SWCR403164025	1 1/2 x 1	48.3	40.9	33.4	26.6	64	0.3
SWCR403165040	2 x 1 1/2	60.3	52.5	48.3	40.9	76	0.5
SWCR403166550	2 1/2 X 2	73.0	62.7	60.3	52.5	89	0.8
SWCR403168050	3 x 2	88.9	77.9	60.3	52.5	89	1.0
SWCR403169480	4 x 3	114.3	102.3	88.9	77.9	102	1.7
SWCR403169694	6 x 4	168.3	154.1	114.3	102.3	140	4.1

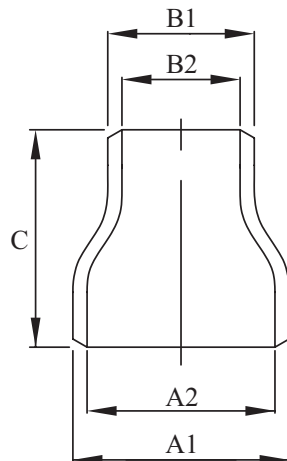

Stainless Steel Buttweld SCH40s Cap (316/316L)

Stainless Steel Buttweld SCH40S 316/316L Cap					
AAP CODE	IMPERIAL SIZE	A	B	C	APPROX KG/PC
SWC4031625	1	26.6	33.4	38	0.1
SWC4031632	1 1/4	35.1	42.2	38	0.2
SWC4031640	1 1/2	40.9	48.3	38	0.2
SWC4031650	2	52.5	60.3	38	0.2
SWC4031665	2 1/2	62.7	73.0	73	0.3
SWC4031680	3	77.9	88.9	51	0.4
SWC4031694	4	102.3	114.3	64	1.1

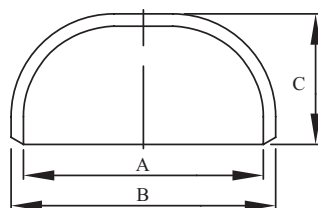

Stainless Steel 316/316L 'Table E' Blind Flanges

Stainless Steel Table 'E' Blind Flanges 316/316L								
AAP CODE	IMPERIAL SIZE	A	B	C	BOLT SIZE	HOLE DIAMETER	NO. HOLES	APPROX KG/PC
SSFBE31625	1	115	83.0	10.6	M12	14	4	0.6
SSFBE31632	1 1/4	120	87.0	10.6	M12	14	4	0.7
SSFBE31640	1 1/2	135	98.0	10.6	M12	14	4	1.0
SSFBE31650	2	150	114.0	10.6	M16	18	4	1.4
SSFBE31665	2 1/2	165	127.0	10.6	M16	18	4	1.7
SSFBE31680	3	185	146.0	11.6	M16	18	4	2.4
SSFBE31694	4	215	178.0	14.0	M16	18	8	3.7
SSFBE31696	6	280	235.0	17.5	M20	22	8	8.0
SSFBE31698	8	335	292.0	20.0	M20	22	8	13.0

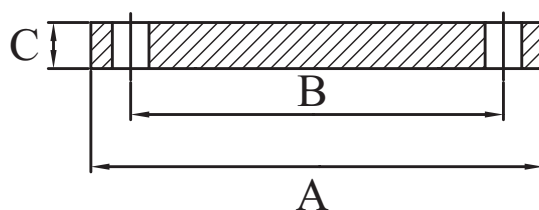

Stainless Steel 316/316L 'Table D' Blind Flanges

Stainless Steel Table 'D' Blind Flanges 316/316L								
AAP CODE	IMPERIAL SIZE	A	B	C	BOLT SIZE	HOLE DIAMETER	NO. HOLES	APPROX KG/PC
SSFBD31694	4	215	178	10.6	M16	18	4	3.0
SSFBD31696	6	279	235	13	M16	18	8	6.49
SSFBD31698	8	337	292	13	M16	18	8	9.28
SSFBD316X25	10	406	356	16	M20	22	8	16.14

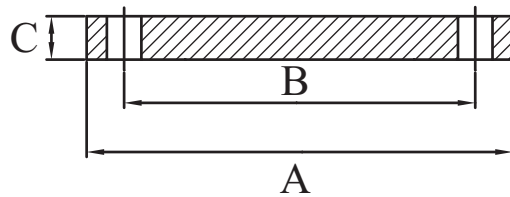

Stainless Steel 316/316L 'Table E' Slip On Flanges

Stainless Steel Table 'E' Slip On 316/316L								
AAP CODE	IMPERIAL SIZE	A	B	C	BOLT SIZE	HOLE DIAMETER	NO. HOLES	APPROX KG/PC
SSFSE31625	1	115	83	10.6	M12	14	4	0.5
SSFSE31632	1 1/4	120	87	10.6	M12	14	4	0.6
SSFSE31640	1 1/2	135	98	10.6	M12	14	4	0.9
SSFSE31650	2	150	114	10.6	M16	18	4	1.1
SSFSE31665	2 1/2	165	127	10.6	M16	18	4	1.3
SSFSE31680	3	185	146	11.6	M16	18	4	1.8
SSFSE31694	4	215	178	14.0	M16	18	8	2.6
SSFSE31696	6	280	235	17.5	M20	22	8	4.9
SSFSE31698	8	335	292	20.0	M20	22	8	7.5

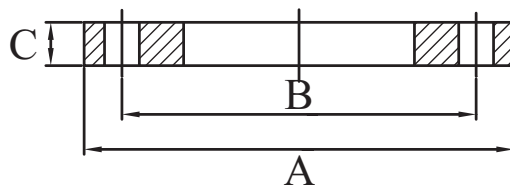

Stainless Steel 316/316L 'Table D' Slip On Flanges

Stainless Steel Table 'D' Slip On 316/316L								
AAP CODE	IMPERIAL SIZE	A	B	C	BOLT SIZE	HOLE DIAMETER	NO. HOLES	APPROX. KG/PC
SSFSD31694	4	215	178	10.6	M16	18	4	2.1
SSFSD31696	6	280	235	17.5	M16	18	8	3.92
SSFSD31698	8	335	292	20.0	M16	18	8	5.24
SSFSD316X25	10	406	356	16	M20	22	8	8.68
SSFSD316X30	12	457	406	19	M20	22	12	11.6
SSFSD316X35	14	525	470	22	M24	26	12	19.2
SSFSD316X40	16	580	521	26	M24	26	12	22.5

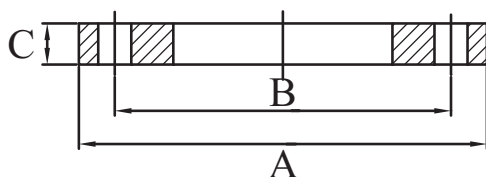

Stainless Steel 316/316L Table 'E' BSP Flange

Stainless Steel Table 'E' BSP Flange 316/316L								
AAP CODE	IMPERIAL SIZE	A	B	C	BOLT SIZE	HOLE DIAMETER	NO. HOLES	APPROX. KG/PC
SSFEBSP31615	1/2	95.3	66.7	15.8	M12	14	4	0.34
SSFEBSP31620	3/4	101.6	73.0	17.4	M12	14	4	0.45
SSFEBSP31625	1	114.3	82.6	18.2	M12	14	4	0.57
SSFEBSP31632	1 1/4	120.7	87.3	19.0	M12	14	4	0.79
SSFEBSP31640	1 1/2	133.3	98.4	21.4	M12	14	4	1.02
SSFEBSP31650	2	152.4	114.3	22.2	M16	18	4	1.36
SSFEBSP31665	2 1/2	165.1	127.0	26.2	M16	18	4	1.7
SSFEBSP31680	3	184.1	146.0	27.0	M16	18	4	2.27
SSFEBSP31694	4	215.9	177.8	32.7	M16	18	8	3.18

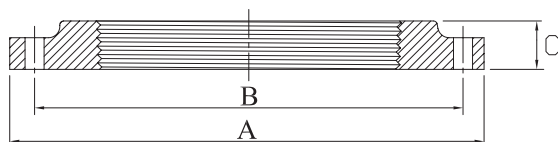

ANSI Stainless Steel 316/316L C150 Blind Flange

Stainless Steel C150 Flange 316/316L								
AAP CODE	IMPERIAL SIZE	A	B	C	BOLT SIZE	HOLE DIAMETER	NO. HOLES	APPROX. KG/PC
SSFB15031625	1	108	79.3	14.5	1/2	16	4	0.9
SSFB15031640	1 1/2	127.1	98.4	17.5	1/2	16	4	1.8
SSFB15031650	2	152.5	120.6	19.1	5/8	20	4	2.3
SSFB15031680	3	190.6	152.4	23.8	5/8	20	4	4.1
SSFB15031694	4	228.7	190.5	23.8	5/8	20	8	7.7
SSFB15031696	6	276.5	241.3	25.5	3/4	22	8	12

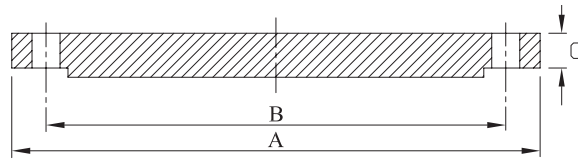

Stainless Steel 316 C150 RF Flange

Stainless Steel C150 RF Flange 316/316L								
AAP CODE	IMPERIAL SIZE	A	B	C	BOLT SIZE	HOLE DIAMETER	NO. HOLES	APPROX. KG/PC
SSFS15031620	3/4	98.5	69.8	15.9	1/2	16.0	4	0.7
SSFS15031625	1	108.0	79.3	17.5	1/2	16.0	4	0.9
SSFS15031640	1 1/2	127.1	98.4	22.3	1/2	16.0	4	1.4
SSFS15031650	2	152.5	120.6	25.5	5/8	20.0	4	2.3
SSFS15031680	3	190.6	152.4	30.2	5/8	20.0	4	3.6
SSFS15031694	4	228.7	190.5	33.4	5/8	20.0	8	5.9
SSFS15031696	6	279.5	241.3	39.7	3/4	22.0	8	8

